

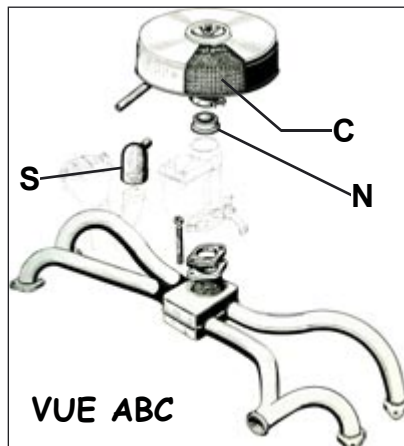

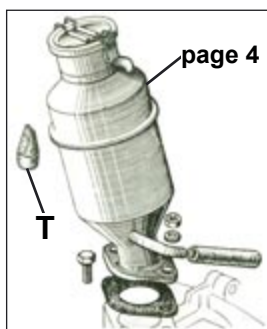

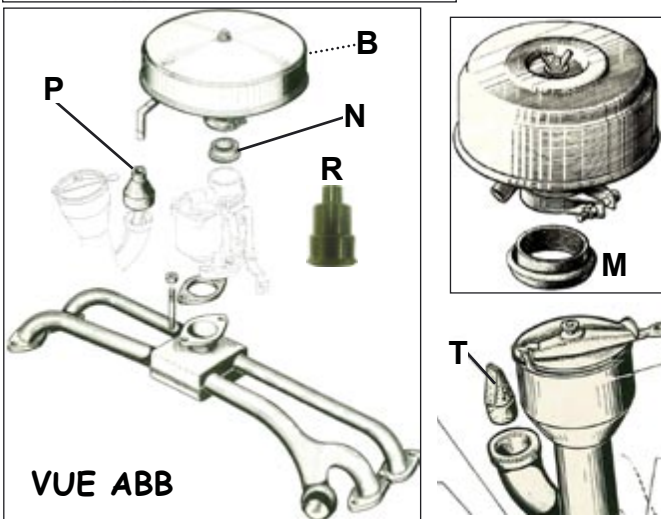

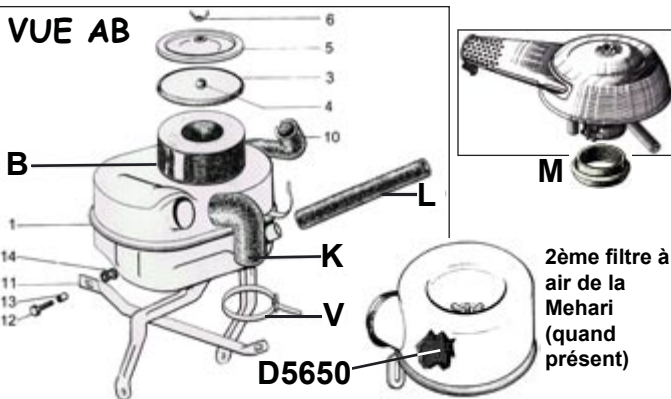

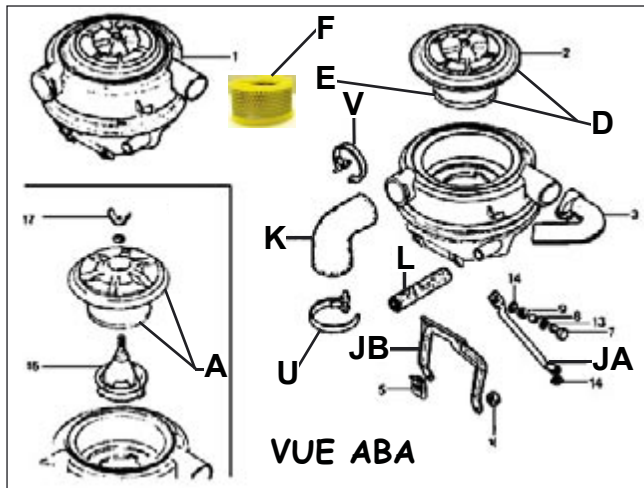







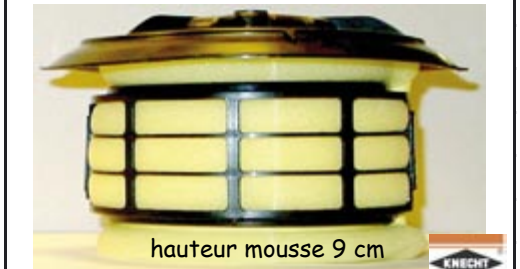

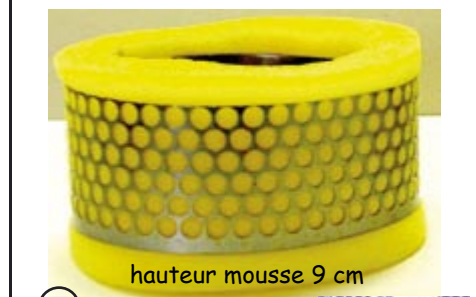





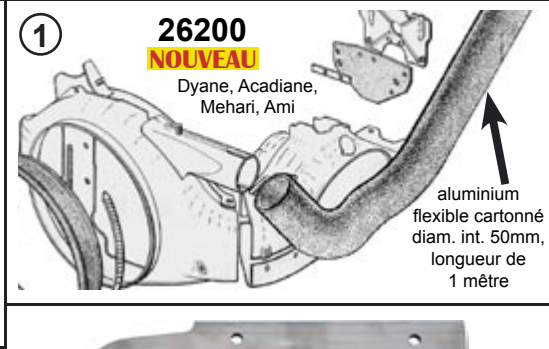



Filtre à Air

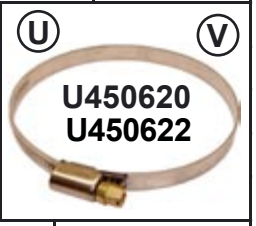

ELEMENTS DE FILTRE A AIR

TTC

A	Filtre à air complet 2cv4-6, Dyane 4-6 >>11/77 avec couvercle fixé par écrou ou papillon	D5610	13.50
B	Cartouche filtre à air 2cv4-6 Dyane 4-6 >11/78 couvercle métal	D5620	12.35
C	Élément pour filtre dans tous boîtiers cloche métallique années 50-60. Hauteur 61mm, si trop haut, utiliser :	D5620 D5642	12.35 15.20
D	Filtre à air complet 2cv6, Dyane 6 11/77>> avec grand couvercle plastique «quart de tour».	D5630	20.60
E	Mousse pour filtre à air 2cv6, Dyane 6 11/77>> seule. Pour couvercle comme modèle D5630 ci-dessus.	D5640	3.80
F	Mousse + grille pour filtre à air 2cv4/6, Dyane 4/6, Mehari 11/77>>. Pour couvercle comme modèle D5630 ci-dessus. (mousse environ 9 cm de haut)	 D5650	18.00
F	Mousse + grille pour filtre à air 2cv4/6, Dyane 4/6 >>11/77. Pour petit couvercle plastique à fixation écrou ou papillon. (mousse environ 6,5 cm de haut)	 D5642	15.20
G	Filtre à air AMI 6 dernier modèle	 D5635 NOUVEAU	15.90
H	Filtre à air LNA VISA AXEL 652cm3	D109161	12.00
JA	Patte tubulaire 2cv6 INOX	D5678	16.00
JB	Patte en "U" 2cv6 INOX	D5679	19.30
1	Conduite entre soufflante et filtre à air (voir page 15)	26200 NOUVEAU	5.00
RACCORDS CAOUTCHOUC			
K	Manchon caoutchouc de entre carburateur et filtre à air		
	- simple corps	D5660	13.45
	- double corps 2cv	D5670	15.50
	- double corps Dyane Acadiane Méhari	D5675	17.30
	- Ami 8	D5677	24.00
L	Durite de reniflard	D5680	7.50
Caoutchouc Carbu-Filtre à air			
M	Carbu de 34 2cv AZ, AZU, Ami...	D5658	3.00
N	Carbu de 26 2cv AZ, AZU, si présent	D5659	3.25
Capuchon de reniflard			
P	- jusque 1954	D5233	27.50
R	- 1954 - 02/1963	D5231	6.50
S	- 03/1963 - 09/1967	D5230	6.50
T	"Bec de canard" de reniflard	D5232	1.90
U	Collier de Manchon double-corps coté carburateur	U450622	0.90
V	Collier de Manchon double-corps coté Filtre à air et Simple corps des deux cotés	U450620	0.90

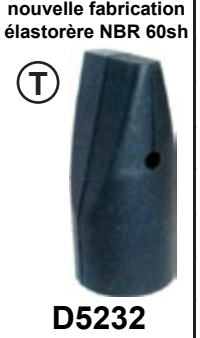
 <p>hauteur mousse 6,5cm</p> <p>(A) D5610</p> 	 <p>(B) D5620 (C)</p>	 <p>hauteur mousse 9 cm</p> <p>(D) D5630</p> 			
 <p>hauteur mousse 9 cm</p> <p>(E) D5640</p>	 <p>hauteur mousse 9 cm</p> <p>(F) D5650</p> 	 <p>hauteur mousse 6,5 cm</p> <p>(F) D5642</p> 			
 <p>(G) 160 x 115 x 50 D5635</p>	 <p>(H) D109161</p>	<p>(I) 26200 NOUVEAU Dyane, Acadiane, Mehari, Ami</p>  <p>aluminium flexible cartonné diam. int. 50mm, longueur de 1 mètre</p>	 <p>(JA)</p>		
 <p>(K) AMI 8 D5677</p>	 <p>(L) D5680</p>	 <p>(JB) D5679</p>	 <p>D5678</p>		
 <p>(K) D5675</p>	 <p>(K) D5660</p>	 <p>(K) D5670</p>	 <p>(U) (V) U450620 U450622</p>		
 <p>(M) D5658</p>	 <p>(N) D5659</p>  <p>COLLERETTE AZ/171/76</p>	 <p>(P) D5233</p>	 <p>(R) D5231</p>	 <p>(S) D5230</p>	<p>nouvelle fabrication élastorère NBR 60sh</p>  <p>(T) D5232</p>