















































CA	Collier supérieur de colonne ancienne	D3791	TTC 19.90
CB	Bague plastique et caoutchouc	D3793	2.90
CC	Collier en bas de colonne	D3785	2.95
CD	Vis du collier CC	D3786	1.50
<u>Joint de bas de colonne pour</u>			
CE	ancienne	D3787	5.95
CF	récente	D3789	4.40
CG	Colonne de direction nue	D3713	71.00
CH	Manchon - Fourreau de colonne	D3714	21.50
CJ	Ecrou-Frein sur CD	D8903	0.15
CK	Ecrou sur CA	D8914	0.10
CL	Volant Monobranch Mousse	D3715	99.00
CN	Cache Central Noir seul	D3716	10.50
CM	Volant 2 branches Noir	D3717	59.00
CO	Cache Central Noir seul	D3718	5.70
CP	Cale caoutchouc Ancienne	D3782	4.75
CR	Flector de Direction + visserie LN LNA VISA C15 504/1973> BX 204 304 404 505 R12	D074849	8.50
Volants Sport ou Custom		Voir page 98	
ANTIVOL - NEIMAN			
NA	Antivol complet 2cv et Mehari	D3792	129.50
NB	Boîtier contacteur 3 fils	D3796	22.90
NC	Bague de Blocage	D3794	34.00
ND	Cosse femelle pour neiman	U460010	0.55
NE	Bride seule	NOUVEAU D3781	6.90

CREMAILLERE

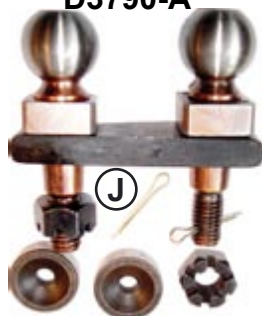
A	Pignon avec roulement 8 dents	D3750	24.95
	7 dents	D3755	26.80
	7 dents décollées 1er modèle	D3756	38.00
B	Écrou de pignon avec joint		
	- Tête hexagonale montage facilité	D3758	11.20
	- Tête crantée comme d'origine	D3754	7.90
C	Embout de barre de direction		
	VOIR NOTE IMPORTANTE PAGE 29		
	Pas de vis normal	D3760-1	23.00
	Pas de vis inversé	D3760-2	23.00
D	Soufflet de barre de direction	D3770	4.50
E	Caoutchouc anti vibrations	D3772	2.80
F	Douille à aiguille en bas du pignon de crémaillère 8 dents	D3759	18.90
F	Bague pour 7 dents sauf D3756	D3757	5.90
G	Écrou d'embout de direction	D3788	3.00
G+2xM+N+U	Kit pour 1 embout	D3783	11.00
H	Crémaillère 7 dents	D3795-7	34.00
	8 dents	D3795-8	92.00
J	Kit de réparation des leviers		
	- modèle avec écrous frein	D3790	35.90
	- ancienne avec écrous crénelés et goupilles	D3790-A	40.90
K	Dé de rotule de crémaillère (1)	D3773	4.50
L	Rivet de bague d'usure	D3774	1.70
LB	Bague d'usure Cote Standard	D3771	12.50
M	Siège demi-lune	D3780	4.50
N	Ressort	D3784	3.50
P	Cache Mobile de Crémaillère	D3761	11.50
Q	Glissière de Cache Mobile	D3762	16.90
R	Ecrou du Collier	D8914	0.10
S	Ecrou-Frein de Rotule	D8902	0.35
T	Kit manchons de réglage		
	d'embouts de barre INOX massif	D3763	31.95
U	Goupille	U450110	0.30
V	Poussoir	NOUVEAU D3776	39.00

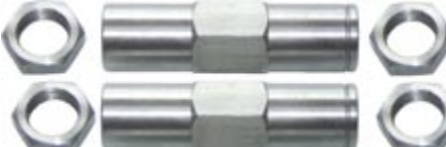
<p>(CN)</p>  <p>D3716</p>	<p>D3791</p>  <p>(CA)</p> <p>D8914 (CK)</p>  <p>D3782</p>  <p>(CP)</p>	<p>D3785</p>  <p>(CC)</p> <p>(CJ) D8903</p>  <p>D3786 (CD)</p> 	<p>(NC)</p>  <p>D3794</p>	<p>(CE)</p>  <p>D3787</p> <p>(ND) U460010</p> 	<p>(CF)</p>  <p>D3789</p>	
<p>D074849</p> <p>Flector de direction LN LNA VISA C15 BX 504/1973> 204 304 404 505 R12</p> <p>(CR)</p> 		<p>(NB)</p>  <p>D3796</p> <p>D8914</p>  <p>(NE)</p> <p>NOUVEAU</p> <p>D3781</p>	<p>(NA)</p>  <p>D3792</p> <p>Avec contacteur</p> <p>Pour 2cv et Méhari uniquement</p>			
<p>D3793</p> 	<p>(CH)</p>  <p>D3714</p>	<p>(CB)</p>  <p>D3793</p>	<p>(CG)</p>  <p>D3713</p>			
<p>(A)</p>  <p>D3750</p>	<p>D3755</p>  <p>D3755</p>	<p>(C)</p> <p>filetage "normal"</p>  <p>D3760-1</p> <p>vérifiez avant l'achat !!!</p> <p>filetage inversé</p>  <p>D3760-2</p>	<p>D3770 (D)</p>  <p>(E) D3772</p> 	<p>(B)</p>  <p>D3754</p> <p>(V) NOUVEAU</p>  <p>D3776</p>		
<p>(F)</p>  <p>D3757</p>	<p>DESSUS DESSOUS</p> <p>(F) D3759</p> 	<p>(N)</p>  <p>D3784</p>	<p>(M)</p>  <p>D3780</p>	<p>(G) D3788</p>  <p>D3773</p> 	<p>(R) D8914</p>  <p>(S) D8902</p> 	<p>D3776</p> 
<p>(P)</p>  <p>D3761</p>		<p>D3762</p> 	<p>(Q)</p>  <p>D3771</p>	<p>(LB) D3774</p>  <p>(L)</p>  <p>D3783</p> <p>G+2xM +N+U</p>		
<p>D3790</p>  <p>(J)</p>	<p>D3790-A</p>  <p>(J)</p>	<p>(U) U450110</p>  <p>(T) D3763</p>  <p>D3763</p> <p>QUALITE INOX MASSIF LA PAIRE</p>	<p>(H)</p>  <p>D3795-7</p> <p>D3795-8</p>			

ECONOMISEZ DES REPARATIONS FUTURES : CHANGEZ VOS SOUFFLETS DE BARRE DE DIRECTION S'ILS SONT DEGRADES.