

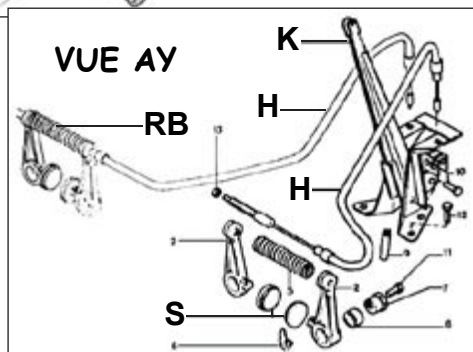

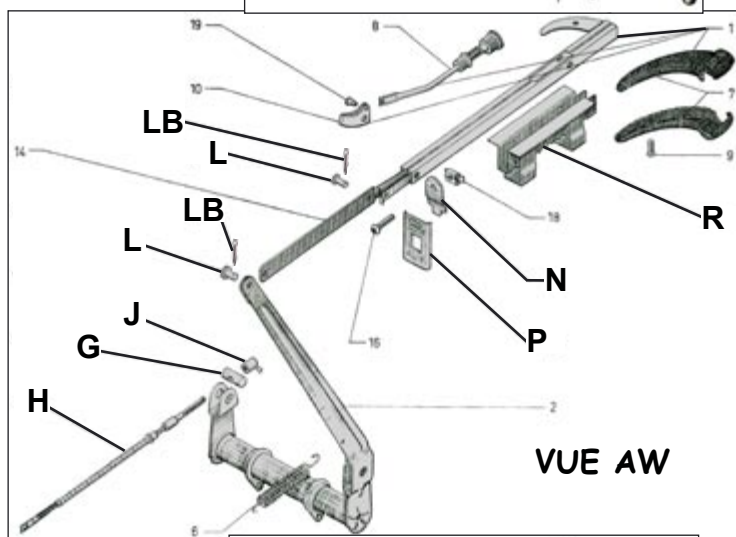

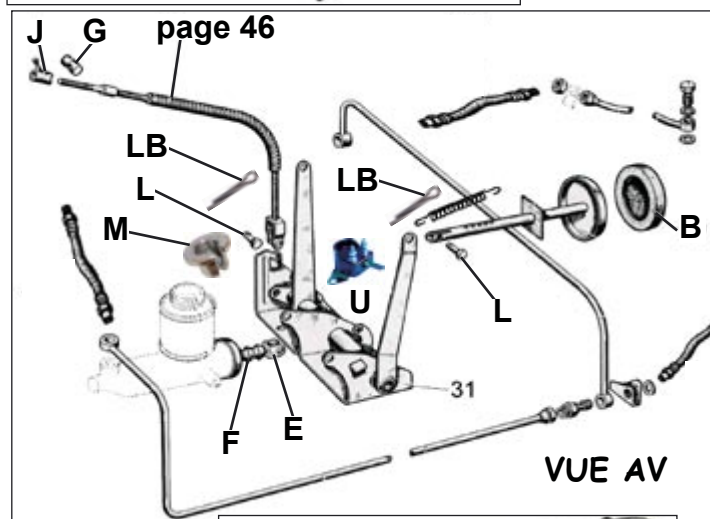

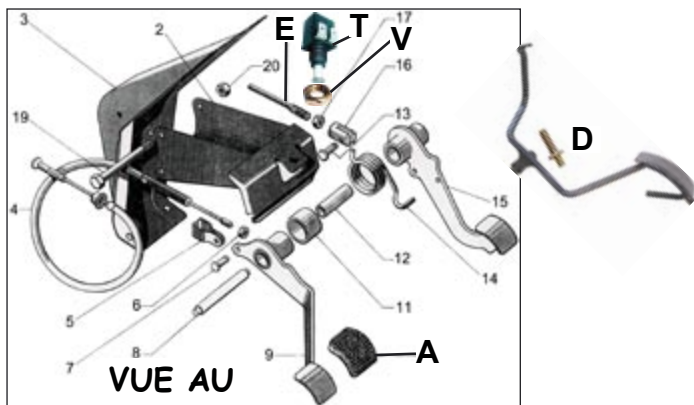



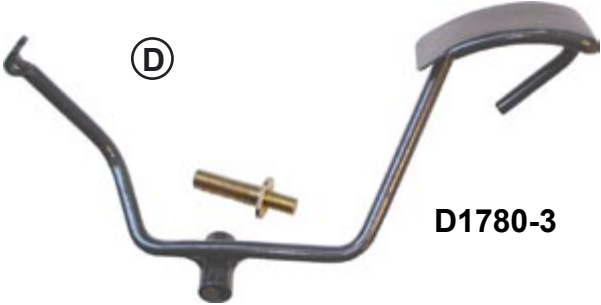

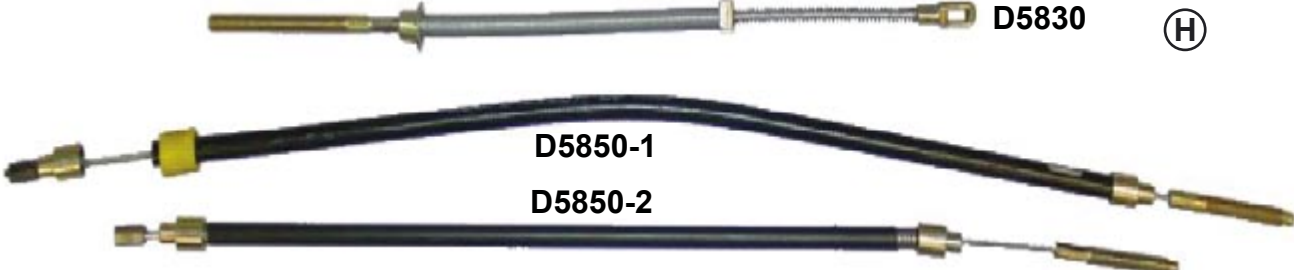

Pédalier - Frein à Main

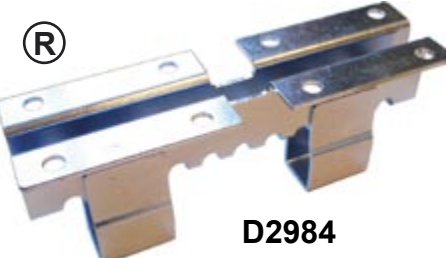

	Couvre pédale de frein ou d'embrayage	TTC
A	Rectangulaire à logo NOUVEAU D1780-4	4.00
A	Rectangulaire à picots D1780-2	3.20
B	Rond pour anciennes D1772	2.90
C	Pédalier d'occasion 2cv4-6 OCC	23.00
D	Pédale d'accélérateur + vis 07/78>> D1780-3	34.90
E	Tige de Poussée de Maître-Cylindre	
	- moteur 425 2ème génération (le collecteur se fixe avec 8 boulons) longueur 103,4mm 03/63>> D2839	12.50
	- 2cv4 2cv6 à partir de 1976 L88mm D2826	5.50
F	Soufflet de Maître-Cylindre D2663	4.50
G	Barillet de Câble de Frein à Main (ou d'embrayage) D5839	3.80
Câbles de frein à main		
H	2cv freins à tambour >>06/81 gauche ou droit D5830	8.00
H	2cv freins à disque 06/81>> gauche D5850-1	10.00
H	droit D5850-2	10.50
J	Écrou papillon (frein à main ou embrayage) D5840	4.90
K	Lever frein à main (disques) D2978	79.00
L	Axe D4414	1.50
LB	Goupille U450110	0.30
M	Butée de Gaine de Cable d'Embrayage ou de Frein à Main (si démontable) D5811	5.90
N	Plaque de Maintien D2980	9.80
P	Plaquette d'étanchéité D2985	5.90
R	Support-crémaillère de levier de frein à main D2984	32.00
RB	Ressort de retour Frein à Main D2987	4.90
S	Plaquettes de Frein à Main Jeu de 4 D2115	8.55
Contacteur Feu Stop		
T	à partir de Janvier 1974 D2790	4.20
U	pour ancienne D2791	18.95
V	écrou spécial pour D2790 D8928 NOUVEAU	1.10

 <p>(A) NOUVEAU D1780-4</p> <p>D1780-2</p> <p>(B) D1772</p>		 <p>(D)</p> <p>D1780-3</p>		
<p>(E)</p>  <p>D2839</p> <p>D2826</p>	<p>réfection des étriers de frein voir page 12</p>	 <p>(F) D2663</p>	 <p>(G) D5839</p>	
 <p>D5830 (H)</p> <p>D5850-1</p> <p>D5850-2</p>				
<p>(J)</p>  <p>D5840</p>	<p>(LB)</p> <p>U450110</p> <p>(L)</p>  <p>D4414</p>	<p>(M)</p>  <p>D5811</p>	<p>(N)</p>  <p>D2980</p>	<p>(P)</p>  <p>D2985</p>
<p>(RB)</p>  <p>D2987</p>	<p>(R)</p>  <p>D2984</p>	<p>commandes d'accélérateur voir page 12</p>		
<p>(K)</p>  <p>D2978</p>	<p>(T)</p>  <p>D2790</p>	<p>(V)</p> <p>NOUVEAU</p> <p>D8928</p>	<p>(U)</p>  <p>D2791</p>	 <p>(S) D2115</p>