

| TARIF PAR REFERENCE |        |
|---------------------|--------|
| D7110               | 49.90  |
| D7115               | 91.00  |
| D7120               | 63.00  |
| D7125               | 107.00 |
| D7210               | 49.90  |
| D7215               | 89.00  |
| D7220               | 63.00  |
| D7225               | 155.00 |
| D7310               | 35.00  |
| D7311               | 115.00 |
| D7320               | 64.00  |
| D7330               | 11.20  |
| D7331               | 57.00  |

|       |        |
|-------|--------|
| D7340 | 14.00  |
| D7341 | 69.50  |
| D7350 | 11.90  |
| D7360 | 7.70   |
| D7370 | 126.75 |
| D7371 | 18.00  |
| D7372 | 47.30  |
| D7373 | 17.50  |
| D7380 | 71.30  |
| D7381 | 178.00 |
| D7382 | 55.00  |
| D7384 | 32.90  |
| D7385 | 34.50  |
| D7419 | 26.15  |
| D7420 | 53.00  |
| D7421 | 190.00 |

|       |       |
|-------|-------|
| D7502 | 2.50  |
| D7504 | 2.50  |
| D7506 | 1.45  |
| D7507 | 2.50  |
| D7508 | 10.70 |
| D7510 | 10.70 |
| D7516 | 1.70  |
| D7518 | 0.80  |
| D7522 | 1.80  |
| D7524 | 1.80  |
| D7528 | 1.00  |
| D7529 | 7.50  |
| D7530 | 7.50  |
| D7531 | 6.00  |
| D7532 | 1.85  |

|   |  |       |        |
|---|--|-------|--------|
| A | Silencieux Avant Ancienne<br>01/1950-11/1963 standard                      | D7110 | 49.90  |
|   |  | D7115 | 91.00  |
|   | Qualité Sup.   | D7120 | 63.00  |
| B | Silencieux Arrière Ancienne std.<br>01/1950-11/1963 Qualité Sup.           | D7125 | 107.00 |
| A | Silencieux Avant Ancienne<br>12/1963-07/1972 standard                      | D7210 | 49.90  |
|   | Qualité Supérieure   | D7215 | 89.00  |
| B | Silencieux Arrière Ancienne Std.<br>12/1963-07/1972 Qualité Sup.           | D7220 | 63.00  |
|   |  | D7225 | 155.00 |
| C | Silencieux Central Récente "cigare"<br>Silencieux Central idem <b>INOX</b> | D7310 | 35.00  |
|   |  | D7311 | 115.00 |
| D | Silencieux Avant "Bête à Cornes"<br>ÉTROIT 435cm3 2cv4                     | D7320 | 64.00  |
|   | LARGE 602cm3 2cv6  | D7420 | 53.00  |
|   | LARGE 602cm3 2cv6 <b>INOX</b>  | D7421 | 190.00 |
| E | Tube Intermédiaire Récente   | D7330 | 11.20  |
| F | Tube Arrière Récente   | D7340 | 14.00  |

**ECHAPPEMENT 2CV6 BERLINE : référence D7305 =  
D7420 + D7330 + D7310 + D7340  
voir encadré en bas de page 65 **102.00****

|    |   |           |        |
|----|---|-----------|--------|
| G  | Tube Arrière Méhari & Fourgonnette  | D7350     | 11.90  |
| H  | Tube Arrière Acadiane   | D7360     | 7.70   |
| J  | Silencieux Avt Ami 6 >05/68 Q. Sup.<br>(vue CD)   | D7370     | 126.75 |
| K  | Tube Intermédiaire Avant Ami 6<br>>05/68 (vue CD)   | D7371     | 18.00  |
| L  | Silencieux Central Ami 6 >05/68<br>Azam6 AK350 Dyane AYA...                                     | D7372     | 47.30  |
| M  | Tube Arrière Ami 6 >05/68 (vue CD)  | D7373     | 17.50  |
| 1  | Kit Complet Fixations et Colliers<br>Pour Vues BY, CA, CC, CE, CF, CJ, CK                       | D7419     | 26.15  |
| NA | Demi-collier pour 375-425cm3  | D7511     | 6.00   |
| N  | Collier Triangulaire Diamètre 49<br>(vue CL) entrée   | D7504     | 2.50   |
| N  | Idem <b>en fonderie</b> comme origine   | D7510     | 10.70  |
| P  | Collier Triangulaire Diamètre 47<br>(vue CL) sortie   | D7502     | 2.50   |
| P  | Idem <b>en fonderie</b> comme origine   | D7508     | 10.70  |
| R  | Collier pour Vues BV, BW, CD  | D7528     | 1.00   |
| S  | Anneau Caoutchouc (vue CL)<br>(2 par voiture)   | D7516     | 1.70   |
| SA | Patte sous caisse avant   | D7529 (*) | 7.50   |
| SB | Patte sous caisse arrière 2cv   | D7530 (*) | 7.50   |
| SC | Patte sous caisse arr. AK Acadiane  | D7531 (*) | 6.00   |
| T  | Bride pour Anneau Caoutchouc<br>(vue CL)  | D7518     | 0.80   |
| U  | Patte de Fixation Rapide Courte<br>(remplace la patte caoutchouc<br>courte et le collier)       | D7522     | 1.80   |
| UB | Patte Caoutchouc Av. Courte<br>Arr. Longue  | D7506     | 1.45   |
|    |   | D7507     | 2.50   |
| UC | Bride Métal sur Patte Caoutchouc  | D7405     | 2.10   |
| UD | Caoutchouc haut   | D7533     | 4.90   |
| V  | Patte de Fixation Rapide Longue<br>(remplace la patte caoutchouc<br>longue et le collier D7526) | D7524     | 1.80   |
| W  | Collier pour Toutes les Autres Vues<br>ou (qualité supérieure)                                  | D7528     | 1.00   |
|    |   | D7532     | 1.85   |
| X  | Collier pour Patte Caoutchouc de<br>Tube Arrière (vue CL. 2 par voiture)                        | D7526     | 2.55   |
| Y  | Vis   | D8911     | 0.30   |
| Z  | Ressort sur boîte de Chauffage  | D7699     | 1.50   |
| ZA | Tube Avant  | D7380     | 71.30  |
| ZB | Silencieux Transversal Avant  | D7381     | 178.00 |
| ZC | Tube Intermédiaire  | D7382     | 55.00  |
| ZD | Tube arrière AZAM6 - AYA  | D7385     | 34.50  |
| ZE | Tube arrière AK350-AZU Export   | D7384     | 32.90  |

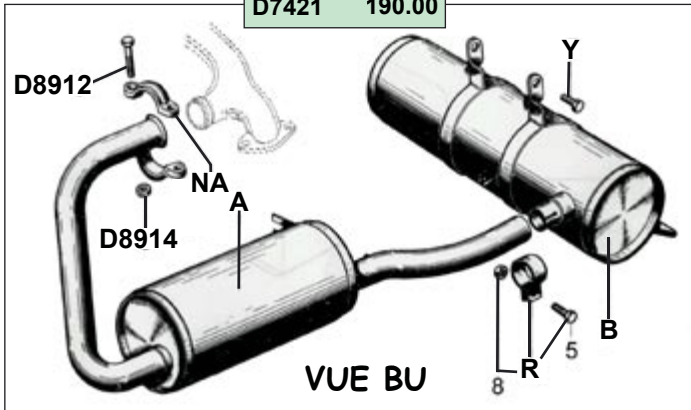

VUE BU







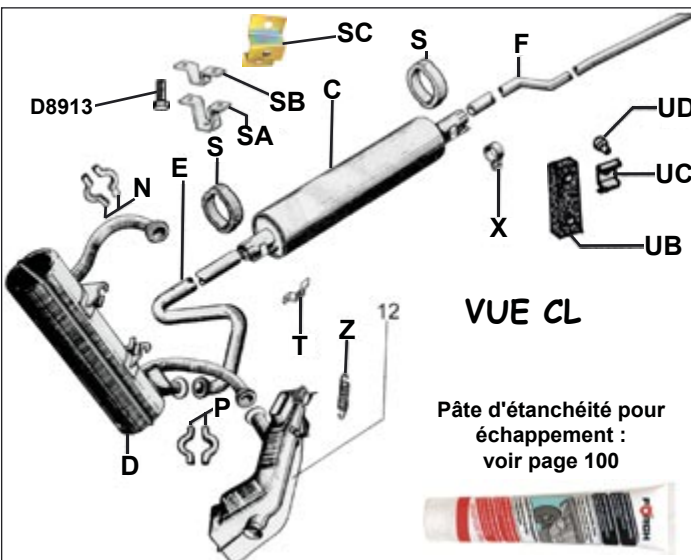
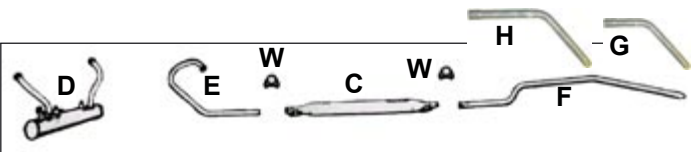





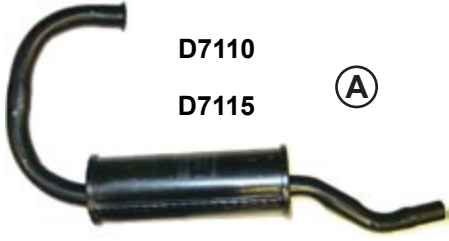
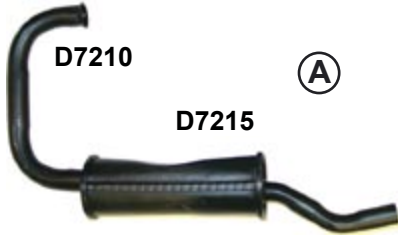

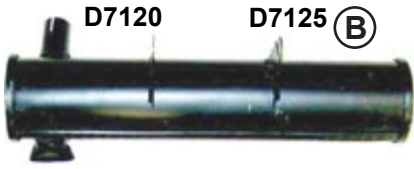
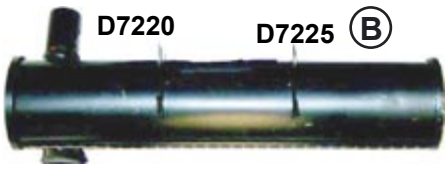







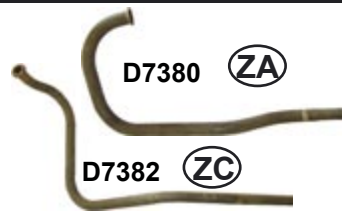

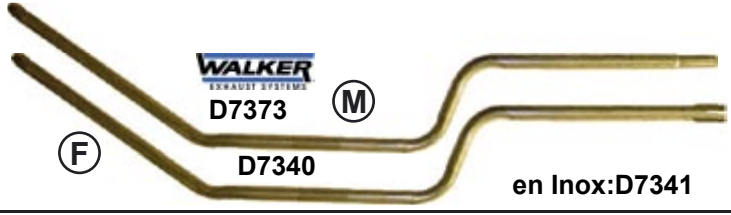

**NOUVEAU**

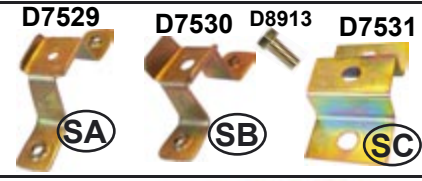
D7540 inox 22.50



VUE CL

Pâte d'étanchéité pour échappement : voir page 100

|   |  |   |  |  |  |
|---|--|---|--|--|--|
|  <p>D7110<br/>D7115 (A)</p>  |  |  <p>D7210<br/>D7215 (A)</p>   |  |  <p>D7370 (J)</p>   |  |
|  <p>D7120 D7125 (B)</p>  |  |  <p>D7220 D7225 (B)</p>   |  |  <p>D7381 (ZB)</p>  |  |
|  <p>D7320 (D)<br/>WALKER EXHAUST SYSTEMS</p>   |  |  <p>D7420 (D)<br/>WALKER EXHAUST SYSTEMS</p>                                 |  |  <p>D7310 (C)<br/>WALKER EXHAUST SYSTEMS</p>               |  |
|  <p>D7311 INOX (C)</p>  |  |  <p>D7421 INOX (D)</p>  |  |  <p>D7360 (H)<br/>D7350 (G)<br/>WALKER EXHAUST SYSTEMS</p> |  |
|  <p>D7372 (L)<br/>WALKER EXHAUST SYSTEMS</p>   |  |  <p>D7380 (ZA)<br/>D7382 (ZC)</p>  |  |  <p>D7371 (K)<br/>WALKER EXHAUST SYSTEMS</p>             |  |
| <p><b>ECHAPPEMENT 2CV6<br/>VOIR ENCADRE EN<br/>BAS DE PAGE.</b></p>   |  |  <p>D7699 (Z)</p>   |  |  <p>en Inox: D7331 (E)</p>                              |  |
|  <p>D7373 (M)<br/>D7340 (F)<br/>WALKER EXHAUST SYSTEMS<br/>en Inox: D7341</p>            |  |  <p>D7533 (UD)</p>  |  |  <p>D7330 (E)<br/>WALKER EXHAUST SYSTEMS</p>            |  |
|  <p>D7529 (SA)<br/>D7530 (SB)<br/>D8913<br/>D7531 (SC)</p>                             |  |  <p>D7385 (ZD)</p>   |  |  <p>D7384 (ZE)</p>                                       |  |
|  <p>D7502 (P)<br/>D7504 (N)<br/>D7506 (UB)<br/>D7507</p>                                 |  |  <p>D7518 (S)<br/>D7516 (T)<br/>D7528 (W)<br/>D7524 (NA)<br/>D7511 (V)</p> |  |  <p>KIT D7419 (1)</p>                                    |  |
|  <p>D7510 (N)<br/>D7508 (P)<br/>D7526 (X)<br/>D7532 (W)<br/>D7405 (UC)<br/>D7522 (U)</p> |  |  <p>D7528 (W)<br/>D7528 (R)</p>  |  |  <p>D7528 (W)<br/>D7528 (R)</p>                          |  |

**COMPOSITION DU KIT D7305 (vue CA) : Silencieux avant D7420 + Tube intermédiaire D7330+ Silencieux central D7310 + Tube de sortie D7340**